



TACTILE MEASURING DEVICES

Coating thickness measurement and material testing

fischer®

“ Fischer impresses with their high-precision measuring instruments, application consulting and comprehensive service. For us, they are a permanent partner for measuring coating thickness. ”

Beate Brand, Head of Quality Lab at KNEISSLER Brünieretechnik GmbH, DE



Trusting number 1. The world's best in measuring technology and service performance.

Your success is in your hands – and we make a measurable contribution to it. Reliable quality control is required, especially when coating systems are becoming increasingly complex and the demands placed on materials are growing. Whether for coating thickness measurement or material testing, the Helmut Fischer Group is your partner for high-precision tactile measuring technology. Our extensive product portfolio offers you first-class measurement solutions with a wide range of different measuring methods that make your work on site measurably easier and actively support you in improving the quality of your products.

According to our motto "Measuring Made Easy" a measuring challenge is easy to use if you, as a customer, use the right measurement technology. As part of our all-round, worry-free package we are there for you from the first joint consultation meeting to your first self-measurement – and well beyond. In order to offer you the highest quality, the majority of our devices – from single parts to software – are developed and produced in Germany.

Focus on what really matters – your work. We take care of the rest.



Company headquarters in Sindelfingen, Germany

Helmut Fischer – Measuring Made Easy

The knowledge and willpower of our founder, Helmut Fischer – his inventive genius and irrepressible desire to implement – are the driving force behind an exemplary company development. In 1953, this success story began with the founding of a two-man company in Stuttgart, Germany. Today, the Helmut Fischer Group is a global player at the forefront of industrial measurement technology.

Innovation and expertise

When it comes to surface measurements, we are state-of-the-art worldwide. Our vow is to continuously develop and produce technology-leading products that make our customers measurably more efficient. Our high-tech devices measure coating thicknesses down to the nanometer range and are used wherever precision, reliability and ease of use are required.

Customized product solutions

Our portfolio is diverse, with each solution perfectly matched to your requirements and wishes. Your big advantage: Fischer offers everything you need from one single source, whether simple handheld devices for quick measurements on the go, to XRF analysis, or fully integrated high-end systems for automated production monitoring.

Excellent customer service

With 21 subsidiaries worldwide and a large network of authorized distributors, we are there for our customers in almost every country. From the first joint consultation to your first self-measurement, our experts from sales, application laboratory, and service will ensure individual, fast, and uncomplicated onsite support.

Quality and safety

If you assure quality in your products, you should work with quality measuring devices. For many decades, the Helmut Fischer Group has stood for outstanding products at the highest level. Absolutely reliable measured values – this is our commitment to our customers. That is why we develop our measuring devices in-house and produce most of them at our company headquarter in Germany. In addition, we are certified according to ISO 9001.

Environment and sustainability

We stand for responsible and resource-saving actions while developing sustainable measurement solutions. With optimized processes and technologies, we reduce environmental impact to a minimum. Whether recycling or upcycling, corresponding material and energy savings benefit not only the environment but also of our customers.

1953



How it all began ...

The ambitious start

The Helmut Fischer Group proudly looks back on a long and successful company history that began in 1953. At the age of only 22, Helmut Fischer founded the company "Schuhmann and Fischer" in a small workshop in Stuttgart, Germany, together with his mentor and former physics teacher Schuhmann.

The expansion

A few years later, Helmut Fischer founded the company of the same name with headquarters in Sindelfingen. Bolstered by the German economic miracle of the 1950s and 1960s, the Swabian one-man business became an international company.

The innovations

At the beginning of the 1980s, Fischer greatly expanded its product range. In 1982, the first X-ray fluorescence measuring device was launched. Further measuring and testing devices in the fields of nanoindentation and scratch testing as well as automated measuring solutions followed. Thanks to numerous patented innovations, which still exist today, these devices quickly established themselves in the industrial environment. Terahertz measurement technology joined our product portfolio in 2023.

The technical progress

By continuously developing the components we use, we are still able to produce market-leading measuring instruments in order to support and promote the technical progress of our customers. Our extensive range of accessories also ensures a high degree of customization.

TODAY



The life's work

Building measurement devices that will last for many years has always been very important to Helmut Fischer. The company itself, then, should be just as durable. Our declared goal is to develop measurement solutions that offer our customers added value and support them efficiently in the performance of their work. This focus shapes our work day after day.

The foundation

After five decades at its helm, in 2003, Helmut Fischer transferred his company shares to the Helmut Fischer Foundation. The Foundation was established to support artists and young scientists, and helps to ensure the continuity of the company.

TRUST THE NUMBER 1 IN MEASUREMENT TECHNOLOGY

The Fischer Advantage

Customized. Choose the right device for your application and budget

THE RIGHT DEVICE SOLUTION FOR EVERY REQUIREMENT

Easiest calibration on the market. Achieve maximum accuracy

Reliable measuring results. Outstanding accuracy and precision

BUILT TO LAST. ROBUST CONSTRUCTION FOR PARTICULARLY HIGH DEMANDS

Easy to use. Fast and simple operation thanks to intuitive user guidance

BROADEST PROBE PORTFOLIO ON THE MARKET WITH OVER 100 STANDARD PROBES

Maximum flexibility. Only manufacturer for simultaneous measurement and evaluation with up to eight probes



HIGHEST QUALITY – MADE IN GERMANY

Meeting all challenges. Precise measurement on many surfaces in a wide coating thickness range

QUICK-MEASURE DESIGN. PRECISE MEASURING RESULTS IN JUST A FEW STEPS

Customized. Customized special solutions for tactile measuring tasks on request

Many applications, a solution for everyone

Automotive: Quality assurance of functional and decorative coatings in automotive engineering requires precise testing of coating thickness and material properties. Our devices are proven companions for this.

Applications: Paint and zinc coatings, cathodic dip coating, sound insulation foam

Electroplating: Tight tolerance limits and the highest demands for uniform coating of all parts require precise and repeatable measurement of the coating thickness.

Applications: Electroplated layers, anodic layers

Anodizing: Ensures greater durability and corrosion resistance for aluminum components. During quality control, our devices reliably detect the coating thickness and inspect the aluminum raw material before anodizing.

Applications: Aluminum alloys, aluminum profiles, decorative anodized layers

Paints and varnishes: When it comes to quality assurance of paint and varnish surfaces, you can achieve the most accurate results with the compact Fischer devices, even with very thin coatings.

Applications: Varnish, paint and powder coatings

Electronics: Ensure the functionality of printed circuit boards by measuring layer thickness precisely and non-destructively or testing material properties.

Applications: Copper coatings, solder resist

Aerospace: Rely on solutions for accurate and non-destructive coating thickness measurement and material testing in the aerospace industry.

Applications: Paint coatings, material testing (heat damage), material sorting

Oil, gas and petrochemicals: Fischer offers the right devices for non-destructive testing of surfaces and anti-corrosion coatings in demanding environments such as refineries, chemical plants, in vessels, pipelines and tanks.

Applications: Ferrite and alpha martensite content, polypropylene coatings, thermally sprayed aluminum

Mechanical engineering: Whether small parts, large machines or parts, subjected to high mechanical stress – to protect them from wear and corrosion, coatings must be continuously measured and monitored.

Applications: Powder coatings, hot dip galvanizing

Construction and infrastructure: Our robust devices for coating thickness measurement, dew point determination and surface profile measurement are tailor-made for the highest demands in the construction sector. Zinc fasteners or stainless alloys such as nails, screws or bolts can be tested non-destructively and reliably.

Applications: Paint and powder coatings according to SSPC-PA2, paint on zinc on steel, zinc coatings

Energy: Reliably monitor coating thicknesses in cladding processes in production, battery cells for electromobility, protective coatings on heat recovery systems or check surface protection by high-alloy steel directly on site.

Applications: Cladding layers, Inconel® alloys

Precious metals: Wherever precious metals need to be checked for authenticity quickly and easily, Fischer devices have proven their worth thanks to non-destructive and high-precision measurement.

Applications: Gold and gold alloys, base metal alloys such as tungsten

Marine and traffic engineering: Wherever metal is permanently exposed to aggressive weathering, it must be reliably protected against corrosion. Handy measuring instruments from Fischer are the right solution for determining the thickness of protective coatings precisely and easily.

Applications: Antifouling coatings, iron glimmer coatings

Packaging: Protective coatings on packaging must be regularly monitored during the running process to ensure full functionality. Check release coatings, sealers or protective coatings for pores or cracks quickly and accurately.

Applications: Aluminum and polyethylene coatings

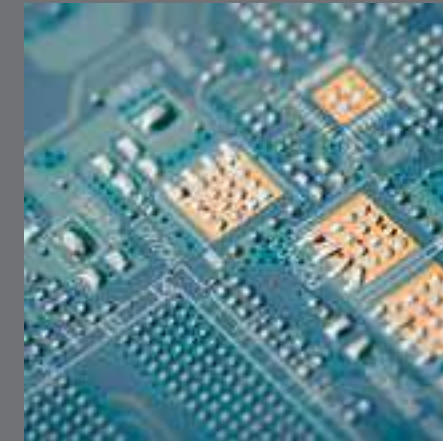

ENVIRONMENT

UNIVERSAL MEASURING ENVIRONMENTS.

- Production: Can be integrated in various production environments
- Quality assurance: Incoming goods inspection and process control
- Laboratory: Research, development, medical laboratories and pharma
- Rough environment: Under the most adverse conditions in free environment
- On site: Mobile use with portable measuring devices indoors and outdoors



AREAS OF OPERATION

THE RIGHT PRODUCT FOR EVERY APPLICATION.

Coating thickness measurement

- Galvanic or metallic coatings
- Precious metal coatings
- Organic coatings (paints, varnishes)
- Anodized coatings
- Anti-corrosion coatings
- Multiple layers (duplex)

Material testing

- Surface profile
- Ferrite and martensite content
- Electrical conductivity
- Climatic environmental conditions

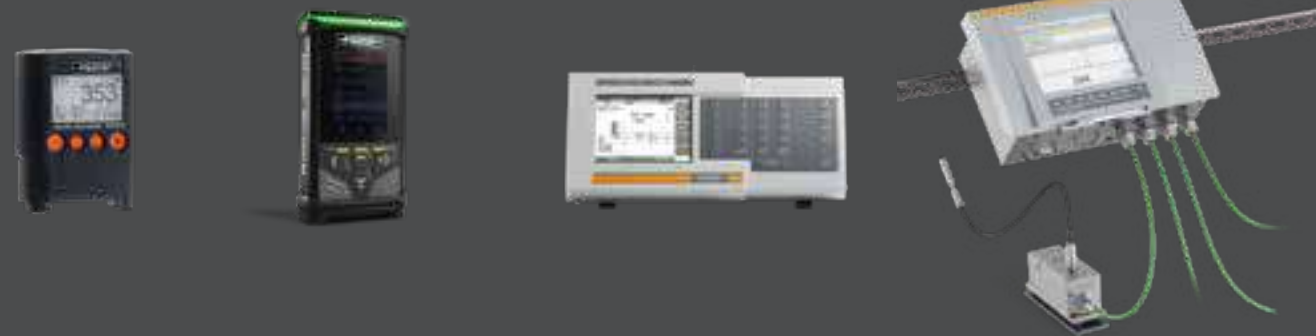

- Portable tactile measuring devices with integrated probe
- Compact handheld devices with changeable probes
- Small benchtop instruments for tactile and destructive test methods
- Automated systems – individually tailored to your requirements

CUSTOMIZED - THE OPTIMAL DEVICE SOLUTION FOR YOUR APPLICATION.

DIMENSIONS

- Magnetic induction method (MI)
- Amplitude-sensitive eddy current method (AE)
- Phase-sensitive eddy current method (PE)
- Magnetic method (M)
- Microresistivity method (MR)
- Duplex method (D)
- Coulometric method (CO)
- Beta-backscatter method (BB)

- Ferrite content (FC)
- Electrical conductivity (EC)
- Dew point (DP)
- Surface profile (SP)

Find out more from page 62.

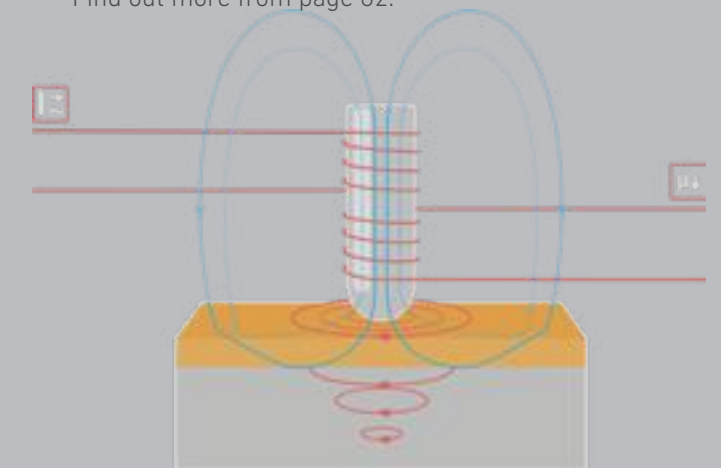

THE RIGHT METHOD FOR YOUR MEASUREMENT.

TEST METHODS

PROBES

ALWAYS THE RIGHT PROBE AT HAND.

- Broadest probe portfolio on the market with over 100 standard probes
- Numerous special probes for the most demanding measurement tasks
- Different housing shapes and properties depending on the application
- Robust and wear-protected probes for best measurement results
- Developed and produced in-house for the highest quality

Find out more on page 54 and 55.



Manual

- Manually placing the measuring probe
- Setting up the probe with help of a manual stand



Semi-automatic

- Setting up the probe with help of a motorized stand
- Placement of the probe by partially automated robotic arms



Fully automatic

- Integration of the measuring probe into fully automated production line
- Placement of the probe by fully automated robotic arms

WAYS TO THE PERFECT MEASURED VALUE.

MEASUREMENT

SOFTWARE

SMART MANAGEMENT AND EVALUATION OF MEASUREMENT DATA.

- Universal software for coating thickness measurement and material testing
- Convenient transferring, evaluation and printing of measured values
- Fast and easy data transfer via USB and Bluetooth
- Versatile evaluation and statistics functions for your data analysis
- Convenient calibration functions
- Fully customizable reports and creation of individual measurement protocols
- Creation and transfer of individual test plans for selected devices
- Tactile Suite: Versatile, modern and user-friendly software solution of the latest generation
- Fischer DataCenter: Proven software with extensive evaluation and statistical functions



- Calibration sets incl. factory certificate for over 500 standards
- Stands with manual and motorized probe lowering, ideal for measuring small parts or parts with complex geometry
- Probe holders for exact positioning of probes
- Devices for precise positioning of specimens
- Device stand for convenient one-hand operation

Find out more from page 58.

FOR PRECISE AND REPRODUCIBLE RESULTS.



STANDARDS & ACCESSORIES

Discover variety, quality and innovation

Measurement	Product family	Headline
Coating thickness measurement	MPO® SERIES	The small all-rounders for mobile coating thickness measurement.
	MMS® Inspection DFT	Heavy corrosion protection – Simple measurement.
	DMP®10-40 SERIES	The all-around capabilities of coating thickness measurement.
	DUALSCOPE® FMP100 and H FMP150	Coating thickness measurement at the highest level.
	SR-SCOPE® DMP®30	First choice for copper thickness measurement.
	PHASCOPE® PMP10	The classic for the most complex applications.
	PHASCOPE® PMP10 DUPLEX	Professional devices for duplex measurements.
	COULOSCOPE® CMS2 and CMS2 STEP	Our coulometry specialist.
	BETASCOPE®	Extra power for special applications.
Material testing	FISCHERSCOPE® MMS® PC2	Multi-talent for coating thickness measurement and material testing.
	FISCHERSCOPE® MMS® AUTOMATION	The inline all-rounder: Multi-measuring system.
	SIGMASCOPE® SMP350	The electrical conductivity measuring expert.
	SIGMASCOPE® GOLD B and GOLD C	Play it safe with gold.
	FERITSCOPE® DMP®30	Specialized for ferrite content measurement.
	MMS® Inspection DPM	Dew point determination made easy.
	MMS® Inspection SPG	Best choice for measuring the surface profile.

Short characteristics	Application	Page
Leading industrial instrument series for fast and easy coating thickness measurement in corrosion protection and industrial applications		20–23
Robust universal device for quick and easy dry film thickness measurement in corrosion protection		24–25
Universal device series for tactile coating thickness measurement thanks to enormously wide probe portfolio		26–29
Instrument series for highest flexibility and control in coating thickness measurement; ideal for the use of test plans		30–31
Robust and powerful handheld device for measuring copper thickness on printed circuit boards		32–33
The most experienced device in our tactile portfolio – reliably solves all special applications		34–35
The specialist for thickness measurement of duplex coatings from automotive to roof panels		
Benchtop instrument for measuring coating thicknesses and electrochemical potentials according to the coulometric method		36–37
The specialist for many coating-base material combinations		40–41
Universal multi-measuring system for parallel coating thickness measurement and material testing with up to eight measuring points		38–39
Universal measuring system for automated coating thickness measurement and material testing	Automation	42–43
Compact handheld instrument for measuring the electrical conductivity of non-ferrous metals	Electrical conductivity	46–47
Special device for mobile and non-destructive authenticity testing of gold, precious metals and coins		48–49
Robust and powerful handheld device for accurate ferrite content and martensite content measurement onsite	Ferrite content	50–51
Robust measuring device for determining the relevant climatic parameters in coating processes in heavy corrosion protection	Dew point	52–53
Reliable surface profile measuring device for optimum paint application at coating processes in heavy corrosion protection	Surface profile	

Get advice from our experts! sales@helmut-fischer.com

COATING THICKNESS MEASUREMENT

MP0® SERIES	20
The small all-rounders for mobile coating thickness measurement.	
MMS® Inspection DFT	24
Heavy corrosion protection – Simple measurement.	
DMP®10-40 SERIES	26
The all-around capabilities of coating thickness measurement.	
DUALSCOPE® FMP100 and H FMP150	30
Coating thickness measurement at the highest level.	
SR-SCOPE® DMP®30	32
First choice for copper thickness measurement.	
PHASCOPE® PMP10 and PMP10 DUPLEX	34
The professional devices for most complex and duplex applications.	
COULOSCOPE® CMS2 and CMS2 STEP	36
Our coulometry specialist.	
FISCHERSCOPE® MMS® PC2	38
Multifaceted for coating thickness measurement and material testing.	
BETASCOPE®	40
Extra power for special applications.	
FISCHERSCOPE® MMS® AUTOMATION	42
The inline all-rounder: Multi-measuring system.	



MPO® SERIES

Robust, handy and lightweight – with the devices of the MPO® series you measure coating thicknesses easily, quickly and non-destructively. With two illuminated displays, a sturdy housing and the intuitive user interface, they are your ideal companion for onsite use.

FEATURES

MPO®



Basic model, probe integrated in the device
Measured value memory: 1,000 in one batch
Without USB interface

MPO®R



Comfort model, probe integrated in the device
Measured value memory: 10,000 in one batch
Rotatable display
Easy data transfer via USB interface
Preinstalled measurement modes

MPO®-FP and MPO®R-FP(W)

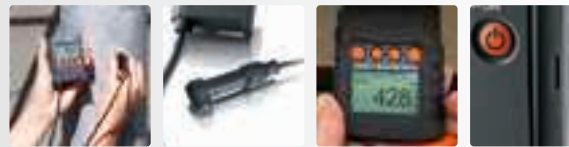

Comfort model, fixed probe with cable or fixed angled probe for challenging geometries
Measured value memory: 10,000 in one batch (MPO®R-FP(W)), 1,000 in one batch (MPO®-FP)
Rotatable display (not MPO®-FP)
Easy data transfer via USB interface (not MPO®-FP)
Preinstalled measurement modes

DUALSCOPE®



Measurement of non-magnetizable or electrically non-conductive coatings on magnetizable or non-magnetizable, electrically conductive base materials

Application examples

Layer	ISO	Anod. coatings	Paint	Varnish	Plastic		
Base Material	NF	Al	Al	Cu	CuZn		
Layer	ISO	NF	Paint	Varnish	Zn	Cr	Cu
Base Material	FE	FE	Steel	Fe			

Test method

Amplitude-sensitive eddy current test method and magnetic induction test method

ISOSCOPE®



Measurement of electrically insulating layers on non-magnetizable, electrically conductive metals

Application examples

Layer	ISO	Anod. coatings	Paint	Varnish	Plastic
Base Material	NF	Al	Al	Cu	CuZn

Test method

Amplitude-sensitive eddy current test method

PERMASCOPE®



Measurement of non-magnetizable layers on magnetizable base materials

Application examples

Layer	ISO	NF	Paint	Varnish	Zn	Cr	Cu
Base Material	FE	FE	Steel	Fe			

Test method

Magnetic induction test method

ISO Electrically non-conductive (isolating) Example: Varnish

NF Non-magnetic (not ferritic, electrically conductive) Example: Zinc

FE Magnetic metal (ferritic) Example: Iron

MPO® SERIES

Built to last. Suitable for thousands of measurements thanks to low wear probe pole

Ideal for onsite use. Compact design and 2-display solution

Perfect fit. The devices of the DUALSCOPE® family automatically select the right test method for your measuring task

Up to all challenges. Precise measurement on many surfaces in a wide range of coating thicknesses

Flexible. Available in many different configurations depending on requirements

Compact. Fits in any pocket



Corrosion protection in crane

The small all-rounders for mobile coating thickness measurement.

The measuring devices of the MPO® series are the compact solution for simple, onsite coating thickness measurement. Practical to use, robust to handle: Use these small handheld devices to measure the thickness of coatings on virtually all metals. Thicknesses for paint or hot-dip galvanized coatings can be determined easily, quickly, and non-destructively for quality control or corrosion protection.

Due to the differently equipped measuring devices, the MPO® series always offers the optimal solution for your application. Both smooth and rough surfaces, and even very thin coatings, can be measured with high precision. Thanks to their three-point support, the instruments can also be placed securely so as to more reliably determine the coating thickness. The integrated conductivity compensation can also equalize differences in the conductivity of non-ferrous metals.



Measurement of anodizing on aluminum frames for building cladding



Measurement at axis connection

Features

- Leading industrial instrument series for fast and easy coating thickness measurement in corrosion protection and industrial applications
- Test method: Magnetic induction and amplitude-sensitive eddy current
- Measured value memory: 10,000 (MPO®R) or 1,000 (MPO®) in one batch
- Measurement range MPO®R:
 - DUALSCOPE®: 0 - 2.000 µm
 - ISOSCOPE®: 0 - 1.200 µm
 - PERMASCOPE®: 0 - 2.500 µm
- Limit monitoring via light
- Probe integrated in the device, FP(W) models with attached closed probe for a wide range of applications



VIDEO:

Scan the QR code to experience unboxing, calibration and commissioning of the MPO® series..

MMS® Inspection DFT

Built to last. Extremely robust thanks to dust- and splash-proof housing

Easy calibration. Achieve the highest level of accuracy

Perfect fit. Easy one-hand operation through compact design

Your security. Reliable measurement results thanks to resistant probe pole

Full measuring control. Feedback via light, sound and vibration whether measured values are within tolerance

Modern and intuitive user interface. Rotating display for any viewing angle and in poor lighting conditions



For full corrosion protection with the MMS® Inspection series see also page 52



Measurement of thick coatings

Heavy corrosion protection – Simple measurement.

The MMS® Inspection DFT is part of the triple set MMS® Inspection Corrosion Kit, Fischer's handheld instruments for full corrosion protection.

As an all-rounder, the MMS® Inspection DFT is the perfect choice for coating thickness measurement on steel and non-ferrous metals. The IP65-compliant device delivers absolutely reliable measurement results – even under very harsh maritime conditions. Thanks to the precise dual probe, the instrument automatically detects the base material and impresses with very low measurement uncertainty even when measuring thin layers.

The MMS® Inspection DFT is ideally suited for dry film thickness measurements on both rough and smooth surfaces, for example in the construction of ships, offshore wind turbines, bridges or petrochemical plants.



Corrosion protection coatings in harsh environments



Limit monitoring via light

Features

- Universal device for quick and easy dry film thickness measurement in corrosion protection
- Test method: Magnetic induction and amplitude-sensitive eddy current method
- Measured value memory: 250,000 in 2,500 batches
- Measurement range: 0 - 2,500 μm (FE), 0 - 2,000 μm (NF)
- Robust housing with protection class IP65
- Easy data transfer via USB
- Limit monitoring via light, sound and vibration
- Battery for > 8 h operating time
- Dual probe with high-precision conductivity compensation integrated in the device



VIDEO:

Scan the QR code to experience unboxing, calibration and commissioning the MMS® Inspection DFT.

DMP® 10-40 SERIES

The new DMP®10-40 series sets the standard for tactile and non-destructive coating thickness measurement of magnetized and non-magnetized base materials. The robust and modern design, optimized functionalities, digital probes, and intuitive Tactile Suite® software make these compact handheld devices your perfect companions for any measuring requirement.

FEATURES

DMP®10 and 20



- Basic model
- Measured value memory: 10,000 in one batch
- Easy data transfer via USB-C
- Limit monitoring via light and sound

DMP®30 and 40



- Comfort model
- Measured value memory: 250,000 in 2,500 batches
- Easy data transfer via USB-C and Bluetooth
- Limit monitoring via light, sound and vibration

DUALSCOPE®



Measuring non-magnetized or electrically non-conductive coatings on magnetized or non-magnetized, electrically conductive base materials

Application examples

Layer	ISO	Anod. coatings	Paint	Varnish	Plastic		
Base Material	NF	Al	Al	Cu	CuZn		
Layer	ISO	NF	Paint	Varnish	Zn	Cr	Cu
Base Material	FE	FE	Steel	Fe			

Test method

Amplitude-sensitive eddy current test method and magnetic induction test method

ISOSCOPE®



Measuring electrically insulated coatings on non-magnetized, electrically conductive metals

Application examples

Layer	ISO	Anod. coatings	Paint	Varnish	Plastic
Base Material	NF	Al	Al	Cu	CuZn

Test method

Amplitude-sensitive eddy current test method

DELTASCOPE®



Measuring non-magnetized coatings on magnetized base materials

Application examples

Layer	ISO	NF	Paint	Varnish	Zn	Cr	Cu
Base Material	FE	FE	Steel	Fe			

Test method

Magnetic induction test method

ISO Electrically non-conductive (isolating) Example: Varnish

NF Non-magnetic (not ferritic, electrically conductive) Example: Zinc

FE Magnetic metal (ferritic) Example: Iron

“ The new DUALSCOPE® DMP®40 from Fischer sets new standards in terms of robustness, ease of operation, and data export, thus making daily quality control in our production easier. ”

Beate Brand, Head of Quality Lab at KNEISSLER Brünieretechnik GmbH, DE

DMP®10-40 SERIES

Built to last. Next level quality and durability thanks to all-aluminum housing

Full measuring control. Feedback via light, sound and vibration whether measured values are within tolerance

Perfect fit. Measure 24/7 due to quick and easy battery change

Digital probes. Fully digitized probes for the most demanding measurement tasks

Backward compatible. Use all of your existing Fischer probes thanks to exchangeable adapter

Powerful software. Automatic device recognition, easy data export and comprehensive reporting



Burnished rails

The all-around capabilities of coating thickness measurement.

The measuring devices of the DMP®10-40 series are the perfect solution for fast and non-destructive coating thickness measurement on magnetized and non-magnetized base materials. Used primarily in quality assurance, these compact devices are impressive with their robust and ergonomic design and extensive functions.

Depending on the application, you will find the right device in the DMP® family. The DMP®10 and 20 models offer an optimal entry level with extensive functionalities, while the DMP®30 and 40 models also meet higher demands. In addition to the various measuring instruments, a wide range of high-precision digital and analog probes are available.

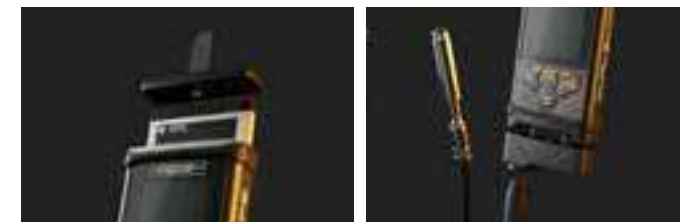

Quick change battery

F-adapter for analog probes

With the intuitive Tactile Suite®, transferring, evaluating and exporting your measurement data is more comfortable than ever before.

Features

- Universal device series for tactile coating thickness measurement thanks to enormously wide probe portfolio
- Test method: Magnetic induction and amplitude-sensitive eddy current method
- Measured value memory: DMP®10/20: 10,000 in one batch, DMP®30/40: 250,000 in 2,500 batches
- Measurement range: Depending on the combination of coating and base material and the used probe
- Robust aluminum housing with protection class IP64
- Replaceable Li-Ion battery for > 24 h operating time
- Easy data transfer via USB-C and Bluetooth
- Limit monitoring via light, sound and vibration
- Digital and analog probes available for various applications



VIDEO and LANDINGPAGE: Scan the QR code and find out more about the DMP®10-40 series.

DUALSCOPE® FMP100

DUALSCOPE® H FMP150

Two in one. Magnetic induction and eddy current method for highest flexibility (FMP100)

Three in one. Magnetic Induction, magnetic and eddy current method for highest flexibility (FMP150)

Inspection plans. Step-by-step measurement guide to reduce user errors

Meeting all challenges. Reliable and fast results for ambitious measurement tasks

Maximum flexibility. Choose the right probe for your application

Easy to use. Fast and simple operation thanks to intuitive menu



Hot galvanized fence

Coating thickness measurement at the highest level.

The DUALSCOPE® FMP100 and DUALSCOPE® H FMP150 are powerful instruments used for a variety of coating thickness measurements. With a large selection of high-precision probes to choose from, these devices are a prerequisite for the demanding and frequently changing measuring tasks in automotive work, electroplating or anodizing, heavy corrosion protection, or in measuring the finest coatings.

The DUALSCOPE® FMP100 combines the magnetic induction and eddy current test methods. Coatings on steel and on non-ferrous metals can be measured precisely without changing the settings on the instrument. The DUALSCOPE® H FMP150 is further equipped with the magnetic method for measuring thick non-magnetic but conductive coatings on iron and steel, as well as nickel coatings on non-ferrous metals.



Measurement of anodizing coating on aluminum on a facade



Measurement of a paint coating on steel

With the inspection plan software Fischer DataCenter IP, which is optionally available exclusively for this instrument series, individual test plans can be created on

a PC and transferred to the measuring instrument. The operator is then guided step-by-step through the measurement sequence of the inspection plan.

Features

- Instrument series for highest flexibility and control in coating thickness measurement
- Test method:
 - FMP100: Magnetic induction and eddy current method
 - H FMP150: Magnetic induction, magnetic and eddy current method
- Measured value memory: For a large number of measurements
- Measurement range: Depending on the combination of coating and base material and the used probe
- Easy data transfer via USB
- Limit monitoring via sound
- High-resolution touchscreen display with a displayable keypad, operable with pen or finger
- Probes available for various applications
- Optionally available: Create test plans individually with supplementary, chargeable software license

SR-SCOPE® DMP®30

Built to last. Next level quality and durability thanks to all-aluminum housing

Full measuring control. Feedback via light, sound and vibration whether measured values are within tolerance within tolerance

Perfect fit. Measure 24/7 due to quick and easy battery change

Digital probe. Fully digitized probe for the most demanding measurement tasks

Powerful software. Automatic device recognition, easy data export and comprehensive reporting

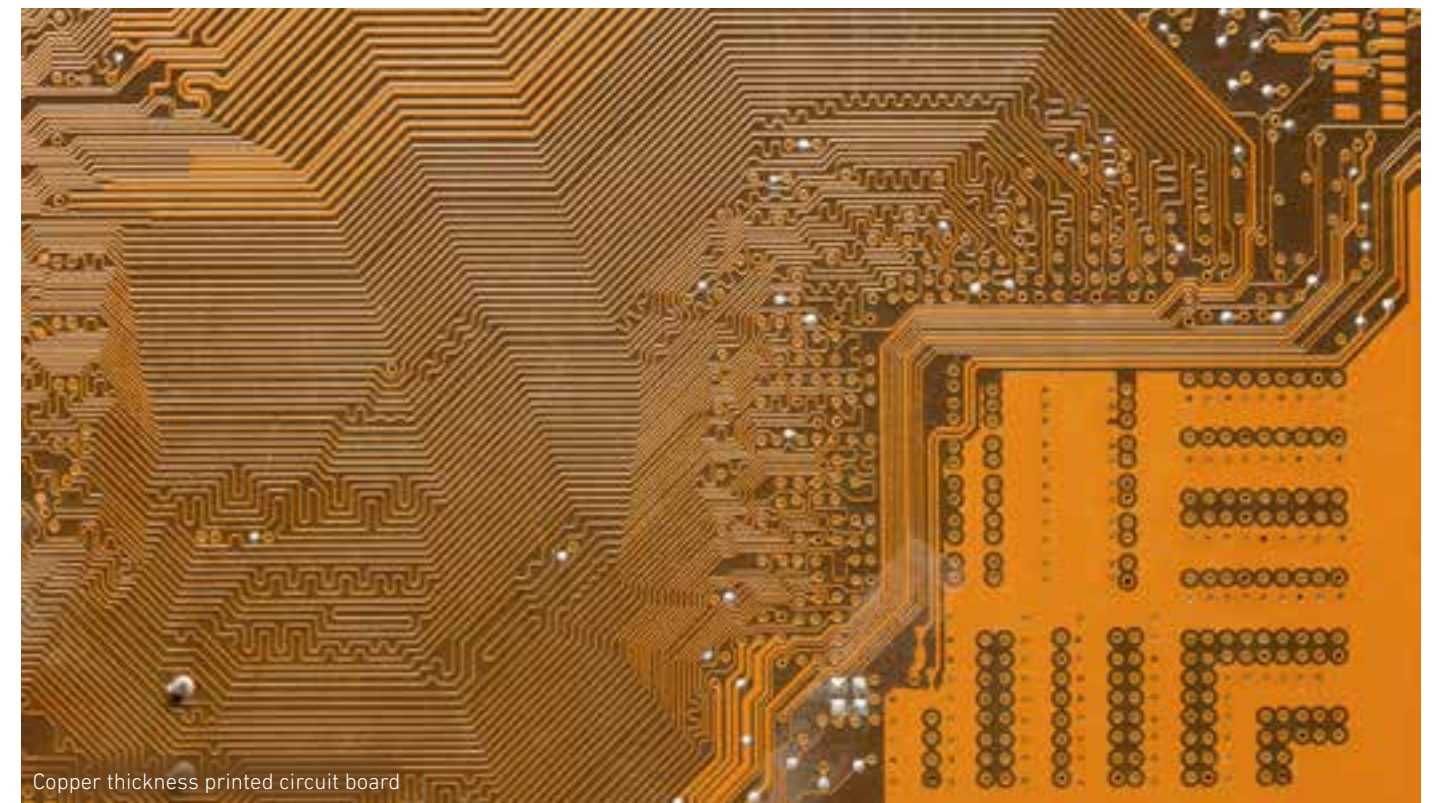

Copper thickness printed circuit board

First choice for copper thickness measurement.

The SR-SCOPE® DMP®30 from the DMP® instrument family has been specially developed for measuring the copper thickness on the top side of printed circuit boards. It is ideal for spot-checking the copper thickness reliably in the production process, incoming or outgoing goods.

This robust handheld device uses the electrical 4-point resistance method in accordance with DIN EN 14571, making it well suited for measuring the thickness of thin copper layers on multi-layer boards or laminates. The other layers of the board or intermediate layers in the PCB, such as deeper insulating copper layers lying, have no influence on the measurement, so that the copper layer thickness can be determined precisely even with thin laminates. The SR-SCOPE® allows measurement in different coating thickness measurement ranges between 0.5 - 10 μm or 5 - 120 μm.

With the intuitive Tactile Suite®, transferring, evaluating and exporting your measurement data is more comfortable than ever before.

Features

- Robust and powerful handheld device for measuring copper thickness on printed circuit boards
- Test method: Microresistivity
- Measured value memory: 250,000 in 2,500 batches
- Measurement range: 0.5 - 10 μm or 5 - 120 μm
- Robust aluminum housing with protection class IP64
- Replaceable Li-ion battery for > 24 h operating time
- Easy data transfer via USB-C and Bluetooth
- Limit monitoring via light, sound and vibration
- Digital probe available



VIDEO and LANDINGPAGE: Scan the QR code and find out more about the SR-SCOPE® DMP®30.



Quick change battery



Special probes for different measurement ranges

PHASCOPE® PMP10 PHASCOPE® PMP10 DUPLEX

Predestined for small parts. Thanks to measurement with the phase-sensitive eddy current test method

Your security. Reliable measurement results on curved measuring surfaces and rough surfaces

Measurement in just one pass. Optimize quality processes and save time when measuring paint and zinc coatings

Three in one. Combines three different test methods (PMP10 DUPLEX)

Quick-measure design. Automatic base material recognition simplifies measurement on steel or aluminum, as probe does not need to be changed



Professional devices for the most complex applications and duplex measurements.

PHASCOPE® PMP10

The PHASCOPE® PMP10 coating thickness device is our classic for the most complex applications. The portable instrument is mainly used in the electroplating and printed circuit board industry for quality control of metal coatings. It is well suited for measuring the coating thickness of nickel, zinc or copper on steel, especially for small parts or rough surface structures. With a special probe design, measurements can also be carried out in printed circuit board holes.

Features

- Universal coating thickness device for complex special applications
- Test method: Phase-sensitive eddy current method
- Measured value memory: 20,000
- Measurement range: Depending on the combination of coating and base material and the used probe 1 - 200 μm
- Data transfer via RS232 interface, optional USB
- Probes available for various applications

PHASCOPE® PMP10 DUPLEX

The PHASCOPE® PMP10 DUPLEX was specially developed for the automotive industry for measuring duplex coatings (paint/zinc on steel or iron) or paint layers on aluminum. The automatic base material recognition simplifies the measurement on steel or aluminum, as the probe does not have to be changed.

Features

- Special device for thickness measurement of duplex coatings from automotive to roof panels
- Test method: Magnetic induction, amplitude-sensitive and phase-sensitive eddy current method
- Measuring mode DUPLEX: Display of paint on zinc on iron or paint on aluminum
- Measuring mode DUAL: Display of total coating thickness (paint and zinc) on iron or paint on aluminum
- Measured value memory: 20,000
- Measurement range: Depending on the combination of coating and base material and the used probe 0 - 2,000 μm
- Data transfer via RS232 interface, optional USB

COULOSCOPE® CMS2 COULOSCOPE® CMS2 STEP

Optimal measurement concept. Predefined measurement tasks for different coating systems

Easy calibration. Achieve the highest level of accuracy

Intuitive operation. Color display and graphically supported user guidance

Maximum flexibility. Exact coating thickness measurement of almost any coating-substrate-combination

Individually expandable. Extensive accessories enable practical work and safe storage



Chromed surfaces

Our coulometry specialist.

Our COULOSCOPE® CMS2 instruments precisely and quickly measure the thickness of virtually any metallic coating, including multi-layer, on almost any base material. It works destructively according to the coulometric method by high-precision electrolytic layer dissolution.

Thanks to their simple handling and menu-supported operator guidance, they are ideally suited for both production monitoring in electroplating industry and incoming inspection of finished parts. Almost 100 predefined measuring applications for different coating systems as well as various de-plating speeds are available as standard.

The sister model COULOSCOPE® CMS2 STEP is additionally equipped with the STEP test function and enables, in addition to the coulometric coating thickness measurement, also the measurement of single coating thicknesses and potential differences of multiple nickel coatings.

Features

- Benchtop instrument for measuring coating thicknesses and electrochemical potentials using the coulometric method
- Test method: Coulometry by anodic dissolution
- Deplating speed: 0.1 - 50 $\mu\text{m}/\text{min}$ selectable
- Deplating area: 0.6 - 3.2 mm \varnothing
- Measured value memory: 3,000 in 50 batches
- Measurement range: Depending on the combination of coating and base material and the deplating speed 0.02 - 50 μm
- Graphical representation of the voltage curve at the measuring cell
- Easy data transfer via USB interface



Measurement of residual tin thickness on printed circuit board



COULOSCOPE® CMS2 STEP workstation with stand and accessories

FISCHERSCOPE® MMS® PC2

One instrument, many possibilities. Enables different test methods for coating thickness, conductivity and ferrite content

Easy to use. Simple device operation and graphically supported user guidance

Perfect fit. Measure manually or semi-automatically; system adapts to your measuring and testing requirements

Unique in the market. Simultaneous evaluation with up to eight probes for maximum flexibility

Individually configurable. Adaptable to the applications of your industry

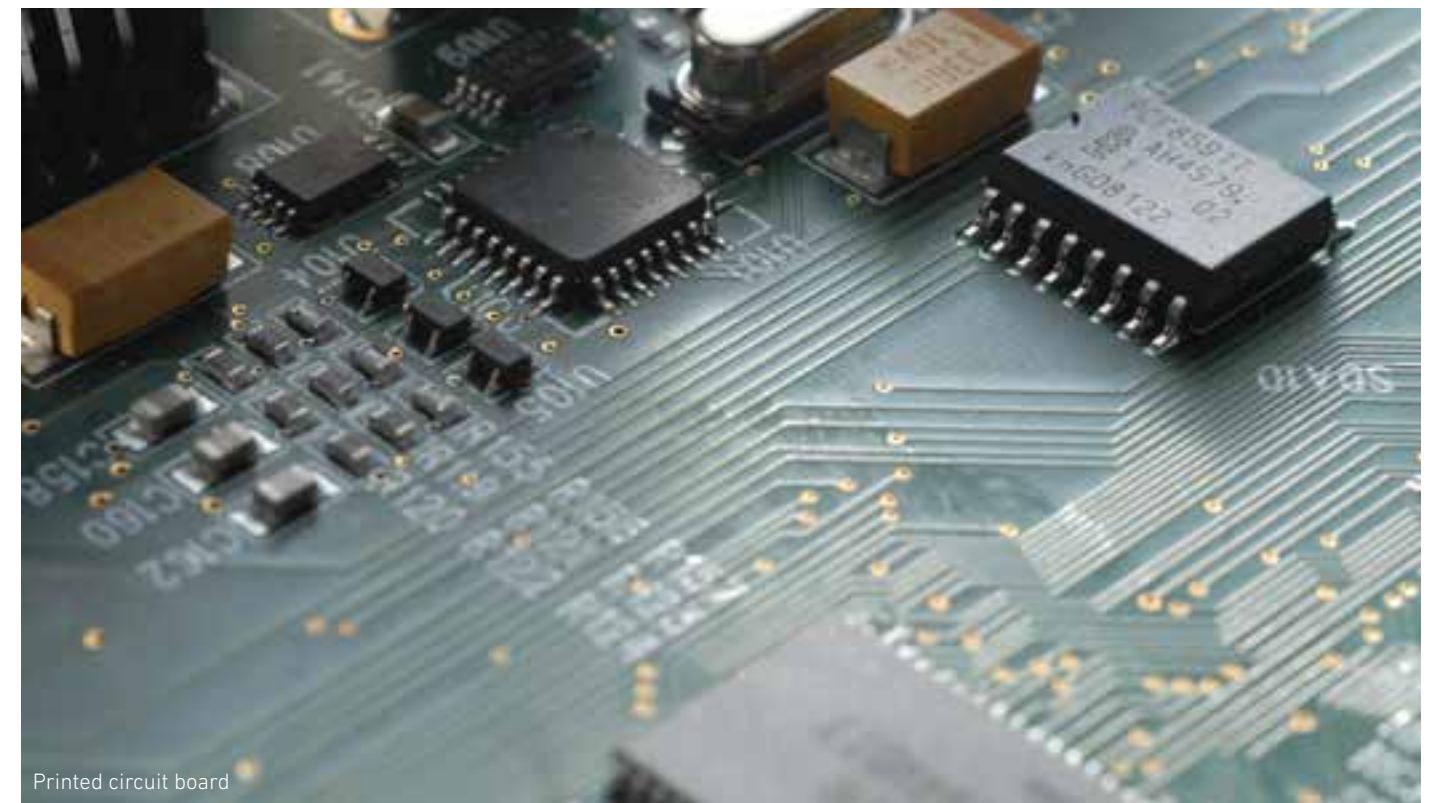

Printed circuit board

Multifaceted for coating thickness measurement and material testing.

The FISCHERSCOPE® MMS® PC2 is a universal all-in-one measuring system for non-destructive and high-precision coating thickness measurement and material testing. Due to its modular design, the MMS® PC2 can be specially adapted to your measuring task and expanded at any time.

The flexible benchtop instrument permits to measure a wide range of physical quantities without having to change. You can choose from up to eight measuring modules with different test methods for coating thickness, electrical conductivity and ferrite content. With up to eight probes measuring in parallel, more than 100 applications can be measured. If required, the measuring system can be integrated into automated production processes.



Nikasil® layers in aluminum cylinders



Eight plug-in modules for > 100 applications

Features

- Universal multi-measuring system for parallel coating thickness measurement and material testing with up to eight measuring modules
- Test method: Amplitude- and phase-sensitive eddy current method, magnetic, magnetic induction, microresistivity and beta-backscatter method
- Measured variables: Coating thickness, electrical conductivity, ferrite content, temperature
- Modules: PERMASCOPE®, SIGMASCOPE®/PHASCOPE®1, PHASCOPE® ESL, SR-SCOPE®, PHASCOPE® DUPLEX, NICKELSCOPE®, BETASCOPE®, Temperature
- Measured value memory: For a large number of measurements
- Measurement range: Depending on the combination of coating and base material and the used probe
- Measurement manually or semi-automatically with motorized stand
- USB and RS232 interfaces
- Probes available for various applications

BETASCOPE®

For special measuring tasks. Thick gold coatings, thin insulating varnishes on electrical steel sheets or oil films on metals

Easy to use. Simple device operation and graphically supported user guidance

Perfect fit. Device fits specifically to your measurement and testing requirements

Unique in the market. Fischer is one of a few measuring instrument manufacturers with beta sources

Automatable. Measure manually or semi-automatically



Extra power for special applications.

The BETASCOPE® is a module for upgrading a FISCHERSCOPE® MMS® PC2 basic instrument for the non-destructive measurement of coating thicknesses according to the beta-backscatter method. The BETASCOPE® is designed to determine the thickness of organic and metallic coatings on a wide variety of substrates, provided that there is a sufficiently large difference between the atomic numbers of the coating and the base material.

Typical applications could be the measuring of thin organic coatings such as nano paint coatings on stainless steel (anti-fingerprint), thick gold coatings down to 35 μm in the aerospace industry, or thin insulating coatings on electrical steel sheets. With the appropriate probe, even soft coatings or liquid oil or lubricating films on metals can be measured.

A temperature sensor integrated in the probe is used to automatically compensate for beta scattering in the air at different temperatures.

Features

- The specialist for many coating-base material combinations
- BETASCOPE® module for upgrading the basic instrument FISCHERSCOPE® MMS® PC2
- Test method: Beta-backscatter, radiometric
- Measured value memory: For a large number of measurements
- Measurement range: Depending on the combination of coating and base material and the used beta emitters
- Measurement manually or semi-automatically with motorized stand
- USB and RS232 interfaces
- Probes and apertures available for various applications



Hand probe with beta emitter



Cylinder head gaskets

FISCHERSCOPE® MMS® AUTOMATION

Easy integration.

Proven Fischer measurement technology as automated solution

Multi-channel measurement.

Simultaneous measurement with up to four probes of the same type in one application

Well connected.

Standardized PROFINET connection to your PLC

Measurement over long distances.

Drag chain capable cables up to 30 m length

Quickly ready for use.

Thanks to simple top-hat rail mounting

Tailor-made. Flexible and modularly scalable, a suitable solution for every application

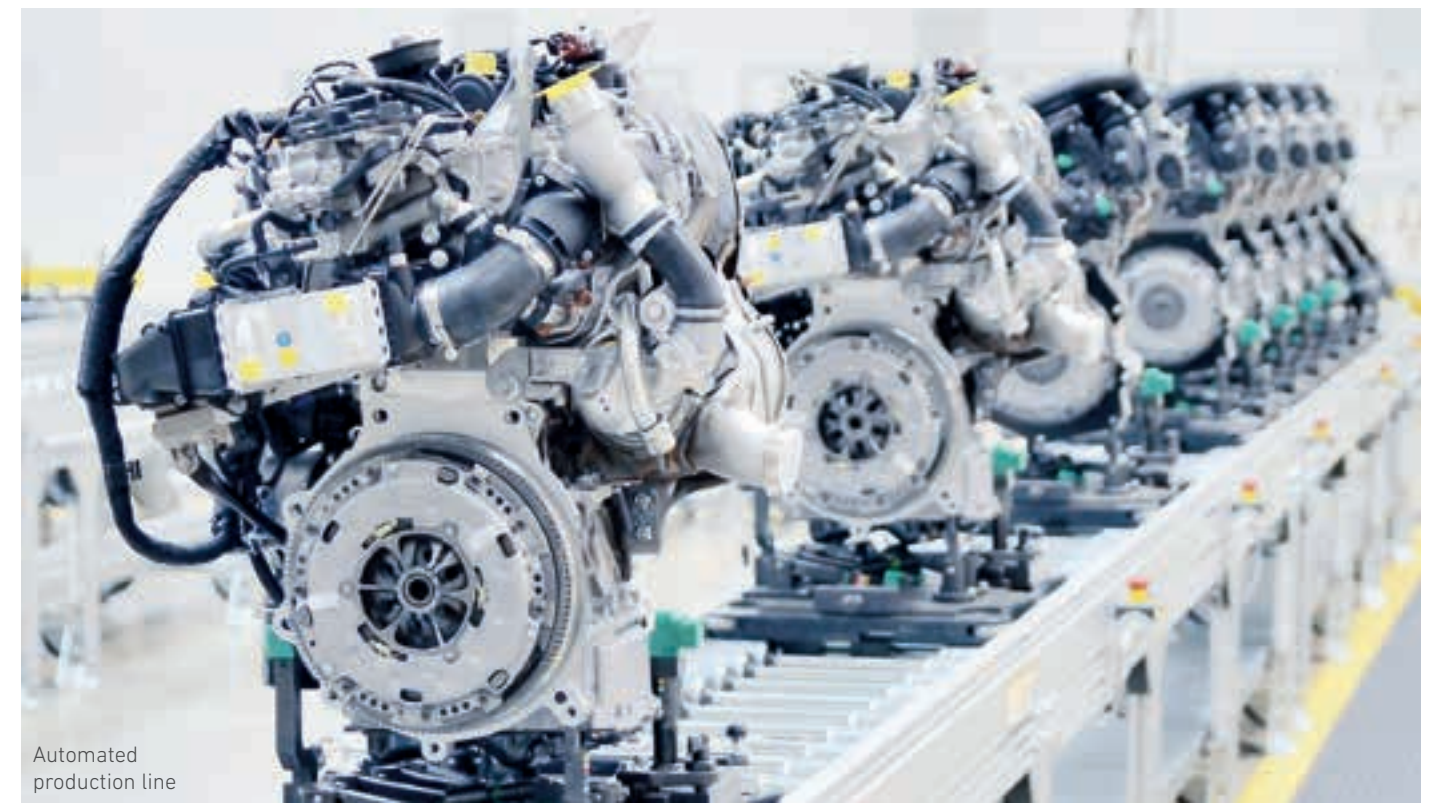

Automated production line

The inline all-rounder: Multi-measuring system.

The FISCHERSCOPE® MMS® Automation is developed for automated coating thickness measurement and material testing. The measured values are recorded using probes that are mounted on a robot arm, for example. The signals reach the base unit via a digitizing unit - the respective MMS® module. The base unit is typically mounted in the control cabinet and is responsible for data processing. It communicates with higher-level units via an RS232 interface or PROFINET.



Measuring module and probe are mounted directly on a inline measuring station (left illustration) or a robot (right illustration)

Due to its modular design, the MMS® Automation provides maximum flexibility: You can equip the device not only with up to four different modules and probes at the same time for solving a wide range of different measuring tasks. Alternatively, up to four of the same probes can be used simultaneously in one application to cover a particularly large number of measuring points. With long cables suitable for drag chains, the device can be placed far away from the measuring station.

Features

- Universal measuring system for automated coating thickness measurement and material testing
- Test method: Magnetic induction, amplitude- and phase-sensitive eddy current method, microresistivity
- Modules: PERMASCOPE®, PHASCOPE® DUPLEX, SIGMASCOPE®, SR-SCOPE®, NICKELSCOPE®
- Measured value memory: A total of 1.000.000 measured values in a maximum of 1.000 applications
- Multi-channel measurement of up to four identical probes in one application
- Measurement range: Depending on the combination of coating and base material and the used probe
- Remote control by your PLC, fast data transfer via PROFINET and RS232
- Probes for various applications available



VIDEO:

Scan the QR code and find out more about the FISCHERSCOPE® MMS® AUTOMATION.

MATERIAL TESTING



SIGMASCOPE® SMP350

46

The electrical conductivity measuring expert.

SIGMASCOPE® GOLD B and GOLD C

48

Play it safe with gold.

FERITSCOPE® DMP®30

50

Specialized for ferrite content measurement.

MMS® Inspection DPM and SPG

52

Dew point determination and surface profile measurement made easy.

SIGMASCOPE® SMP350

Perfect fit. Different measuring frequencies for different penetration depths and measuring tasks

Always in view. Clear management of measurement tasks through user-definable file and folder structure

Predestined for the aerospace industry. Meets Boeing specification BAC 5651 with matching probe

Easy to use. Operation via high-contrast touch-screen with intuitive user interface



Conductivity aluminum raw material

The electrical conductivity measuring expert.

With the SIGMASCOPE® SMP350 you can quickly and accurately determine the electrical conductivity of all non-magnetizable metals such as aluminum, copper and austenitic steels.

The conductivity determined allows conclusions to be drawn about the composition, microstructure or mechanical properties of materials. This results in an extremely wide range of measurement tasks and applications, for example in the quality assurance of raw materials, the evaluation of hardness and strength of heat-treated materials or the control of heat damage, material fatigue and cracks.

The measurement is based on the phase-sensitive eddy current method. This type of signal evaluation enables non-contact measurement, even under paint or plastic coatings up to 500 µm thick.



Decorative anodized layers



Quality assurance in the aviation

Features

- Compact handheld instrument for measuring the electrical conductivity of non-ferrous metals
- Test method: Phase-sensitive eddy current method
- Measured value memory: For a large number of measurements
- Measurement range: 0.3-63 MS/m or 0.5-108 % IACS
- Individual consideration of the temperature coefficient valid for each material
- Easy data transfer via USB interface
- Limit monitoring via sound
- Probes available for a wide range of applications, with and without integrated temperature sensor
- Additional external temperature sensor optional available

SIGMASCOPE® GOLD B SIGMASCOPE® GOLD C

Suitable for the gold industry. Prevents purchase of fake coins and gold bars

Your safety. Distinguish between counterfeit and original in seconds

Well equipped. Perfect complement to your Fischer XRF instrument

See what's behind. Measure even through non-conductive cover layers like foil packaging

Easy to use. Operation via high-contrast touch-screen display with user-friendly user interface



Authenticity testing gold bar

Play it safe with gold.

With the SIGMASCOPE® GOLD B and SIGMASCOPE® GOLD C handheld devices, you can test the authenticity of gold coins, gold bars and precious metals quickly, easily and non-destructively using electrical conductivity.

Using the SIGMASCOPE® GOLD B, you can reliably test the authenticity of gold bars up to a thickness of 17 mm and a weight of up to about one kilogram. Due to its variable penetration depth, gold testing of thinner bars is also possible.

Using the SIGMASCOPE® GOLD C, you are able to check the authenticity of coins and thin bars weighing up to about 100 gram. Whether Krugerrand, ducat, coin gold or fine gold – with the easy-to-use gold tester detect counterfeit goods in seconds.



Gold alloys of coins



Detection of base inclusions like tungsten

With large, color touch screens, these measuring devices are tailor-made for examinations in the laboratory and in the store and can be operated intuitively. Non-contact measurement through plastic packaging up to 0.5 mm thickness is also possible.

Features

- Special device for mobile and non-destructive authenticity testing of gold, precious metals and coins
- Test method: Phase-sensitive eddy current method
- Measured value memory: For a large number of measurements
- Measurement range:
 - GOLD B: Gold bars of approx. 1 oz (31.1 g) - 1 kg
 - GOLD C: Gold coins and bars up to approx. 100 g
- Variable penetration depths to match the thickness of the measured object
- Measuring frequency:
 - GOLD B: 100, 500 and 1.000 Hz
 - GOLD C: 15, 30, 60 and 120 kHz
- Easy data transfer via USB interface
- Limit monitoring via sound
- Probes available for various applications



VIDEO:

Scan the QR code and find out more about the SIGMASCOPE® GOLD C.

FERITSCOPE® DMP®30

Built to last. Next level quality and durability thanks to all-aluminum housing

Full measuring control. Feedback via light, sound and vibration whether measured values are within tolerance

Perfect fit. Measure 24/7 due to quick and easy battery change

Digital probe. Fully digitized probe for the most demanding measurement tasks

Backward compatible. Use your existing Fischer probes thanks to exchangeable adapter

Powerful software. Automatic device recognition, easy data export and comprehensive reporting

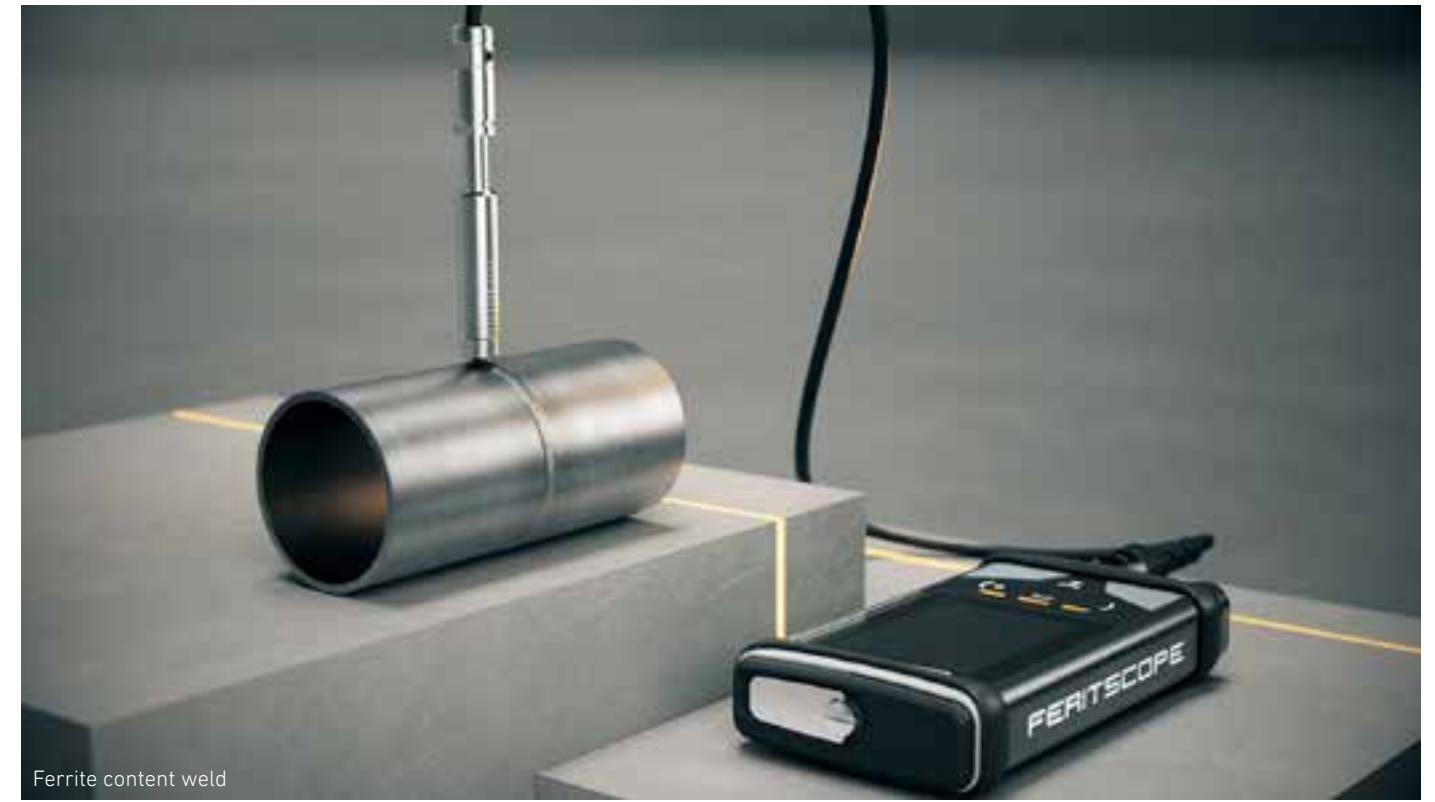

Ferrite content weld

Specialized for ferrite content measurement.

The FERITSCOPE® DMP®30 from the DMP® family is tailor-made for the measurement of ferrite content or martensite content in austenitic and duplex steels.

The advantages of these robust handheld devices are particularly notable in chemical plants, power plants, and process engineering plants. They are ideally suited for onsite measurements of austenitic claddings as well as weld seams in stainless steel pipes, containers, boilers or other products made of austenitic or duplex steel. From a plating thickness of 3 mm, ferrite content determination can be carried out reliably and precisely, regardless of the properties of the base material.



Quick change battery



Ferrite content measurement in the weld seam area

Features

- Robust and powerful handheld device for the measurement of ferrite and martensite content in steels with austenitic microstructures
- Test method: Magnetic induction
- Measured value memory: 250,000 in 2,500 batches
- Measurement range: 0.1 - 80 % Fe or 0.1 - 110 FN
- Robust aluminum housing with protection class IP64
- Replaceable Li-ion battery for > 24 h operating time
- Easy data transfer via USB-C and Bluetooth
- Limit monitoring via light, sound and vibration
- Digital and analog probes available



VIDEO and LANDINGPAGE: Scan the QR code and find out more about the FERITSCOPE® DMP®30.

Even in hard-to-reach places, our digital and analog probes deliver maximum flexibility. With the intuitive Tactile Suite®, transferring, evaluating and exporting your measurement data has never been so convenient.

MMS® Inspection DPM

MMS® Inspection SPG

Built to last. Extremely robust thanks to dust- and splash-proof housing

Easy calibration. Achieve the highest level of accuracy

Perfect fit. Easy one-hand operation through compact design

Full measuring control. Feedback during measurement by light (DPM), light, sound and vibration (SPG)

Modern and intuitive user interface. Rotating display for any viewing angle and in poor lighting conditions

Designed for coating processes. Optimum preparation for the application of anti-corrosion coatings

For full corrosion protection with the MMS® Inspection series see also page 24



Corrosion protection



Flexible to use

Dew point determination and surface profile measurement made easy.

MMS® Inspection DPM

With the MMS® Inspection DPM dew point meter, you can monitor the climatic parameters relevant for coating processes directly before applying the anti-corrosion coating. The handheld device reliably measures relative humidity, air and surface temperature. The measuring probes are integrated for optimum one-hand operation.

Features

- Robust measuring device for determining the relevant climatic parameters in coating processes in heavy corrosion protection
- Measured value memory: 10,000 in one batch or 250,000 in 2,500 batches
- Measurement range: Air temp. -20 to + 60 °C (-4 to 140 °F), Surface temp. -20 to + 80 °C (- 4 to 176 °F), Relative humidity 0- 100 % RH
- Robust housing with protection class IP65
- Battery for > 8 h operating time
- Easy data transfer via USB and Bluetooth
- Limit monitoring via light
- Resistant temperature sensors integrated in the device, additional sensor can be connected

MMS® Inspection SPG

With the MMS® Inspection SPG, you can measure the surface profile in no time at all. The peak-to-valley height differences are measured in accordance with ASTM D4417, Method B. This makes the device suitable for depth measurements of surface profiles meeting regulations and guidelines such as SSPC-PA17. This configuration permits optimal preparation for the application of anti-corrosion coatings.

Features

- Reliable surface profile measuring device for optimum paint application in coating processes in heavy corrosion protection
- Measured value memory: 250,000 in 2,500 batches
- Measurement range: 0 - 500 µm
- Robust housing with protection class IP65
- Battery for > 8 h operating time
- Easy data transfer via USB and Bluetooth
- Limit monitoring via light, sound and vibration
- Probe integrated in the device

PROBES

Wide variety of probes.

Broadest portfolio on the market, the optimum probe for every measuring task

Customized. Probes with different housing shapes and properties

Reliable measurement results. Probes with outstanding measurement accuracy and linearity

Robust and wear-resistant. Best quality for maximum service life

Individual factory calibration. Ensures you the highest level of accuracy

Quality and safety.

Developed and produced in-house for the highest demands

Smart connectivity.

Convenient data transfer via DMP® device via USB-C or Bluetooth

Flexible F-adapter.

Continue to use the full power of analog probes with the DMP® device



Probe measures on sample

The probe – The heart of our measuring devices.

The heart of any electromagnetic measuring system is the probe. It generates the actual signal that is subsequently evaluated. For this reason, it must meet certain requirements depending on the area of application and must not damage soft coatings, for example.

With over 100 standard probes and numerous customized probes, we offer you a comprehensive product portfolio from which you can select the right probe for your measuring task together with us. All Fischer probes are extremely robust, wear-resistant and developed, produced and tested in-house to the highest quality standards. Simply connect the pre-calibrated probe to your measuring instrument and get started: Our devices recognize the probes automatically.

Due to a spring-loaded system, our probes are placed on the surface with an optimal pressure. This reduces measuring errors and leads to high repeatability, which guarantees your measurement results. Probes with integrated curvature compensation allow reliable measurement on curved surfaces. Probes with conductivity compensation, on the other hand, can compensate for different electrical conductivities of the base material and thus avoid time-consuming calibration procedures.

Our experts will be happy to advise you on the selection of the right probe for your application. If required, we also develop individual special designs.

sales@helmut-fischer.com

Features and criteria for probe selection

Depending on the application, our probes have specific properties and meet certain criteria to provide you with a result of highest accuracy. Here are a few examples of measurement conditions for selecting the optimal probe:

- Dimension of measurement area
- Geometry of specimen or the measuring site
- Surface condition of specimen
- Combination of coating and base material
- Thickness of coating and base material
- Coating hardness
- Manual or automated measurement
- Ambient conditions, e.g. wetness

Tactile Suite®



The latest software generation for your coating thickness measurement.

The Tactile Suite® is an efficient software solution with a modern design, innovative user guidance and versatile functions for your evaluations and reporting. Tailored to your needs, The Tactile Suite® is the most intuitive software in tactile coating thickness measurement. It is available for all devices of the DMP® series.



Instantly recognized and synchronized.

With the automatic and reliable device recognition, your probes and devices are recognized directly. Your measurement data is transferred and stored easily and immediately.



Direct export to Excel.

Transfer your measurement data in real time or after measuring directly to Excel or other file formats – easily and conveniently via USB-C or Bluetooth.



Create data reports easily.

Easily create customized reports and measurement logs. Use our templates or adapt them according to your needs.

Measuring easier than ever



Calibrate



Transfer data



Guarantee quality

Measure



Create data report



FISCHER DataCenter

Proven software solution for tactile measurements.

With the Fischer DataCenter you get a proven software solution with extensive evaluation and statistical functions as well as supporting graphical display options. Measured values can be transferred to the PC with just a few clicks via USB or Bluetooth (device-dependent) and managed, evaluated, archived and printed there.



Creation of individual test plans.

Create individual test plans to guide the operator understandably through the measurement sequence of the test plan. The data transfer and evaluation takes place conveniently on the PC (DUALSCOPE® FMP100 only).



Evaluation and statistics functions.

Visualize your data such as histograms and cumulative frequencies graphically or in tabular form using drag-and-drop.



Create data reports easily.

Generate custom reports with your own logos, images, and graphics, or based on scanned forms.

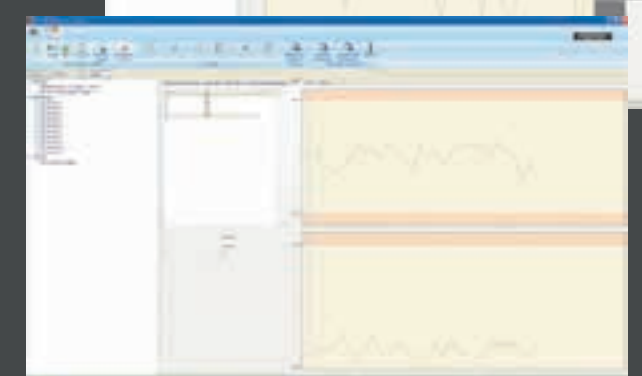
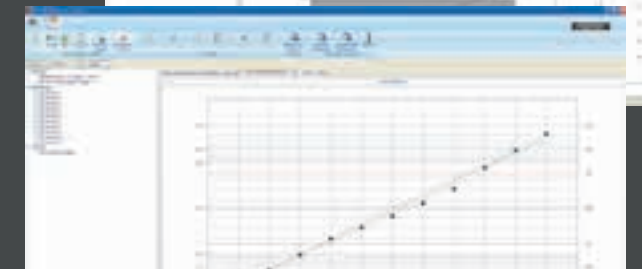
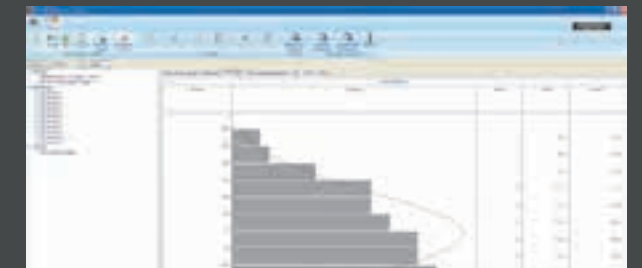

ACCESSORIES

The perfect addition for optimum measurement performance.

Always well supplied with our high-quality accessories

You will find a large selection of add-ons to match our product portfolio. In this way, you can always ensure that you can measure absolutely reliably. We offer you a very large range of probes, manually and motor-driven stands, specimen holders in a wide variety of designs, protective covers for devices, adapters, consumables and much more. Accessories that make your daily use easier.

Our accessories

- Selection from hundreds of standard and special probes; for further details see page 56
- Calibration sets incl. factory certificate for well over 500 standards
- Measuring stands with manual or motorized probe lowering for highest repeatability precision
- Various holders for exact positioning of probes and samples
- Device holder for convenient one-hand operation
- Adapters, batteries, power supplies and USB cable
- Consumables such as electrolytes, cannulas or calibration solutions
- Manufacturer test certificates
- And much more

Our experts will be happy to advise you on finding the right accessories for your application:

sales@helmut-fischer.com



Repeatable measurement with specimen holder and probe clamped in a stand



Stand for clamping internal probes



Holder for comfortable use of a DMP® device



CALIBRATION



Selection of calibration standards

Standards you can rely on

It all depends on the right measure

Only a well-calibrated measuring instrument delivers correct results. For this reason, Fischer relies on the highest accuracy for its calibration standards. Our in-house calibration laboratories produce traceable calibration standards, also known as reference or comparison standards, which are recognized all over the world.

Calibration standards are foils or coated base material. Foil standards can be combined with other materials for further adherence to your measuring task.

Whether coating thickness measurement, material analysis or material testing, with well over 500 different calibration standards, Fischer has the right standards for every application in its range. With prefabricated sets, for example for printed circuit boards, you are also ideally equipped for special tasks.

Safety through our DAkkS calibration laboratory

Fischer runs several accredited calibration laboratories worldwide. Our speciality: We are the first and only company with its own calibration laboratory in Germany that is accredited according to DIN EN ISO/IEC 17025 for the mechanical measurand "mass per unit area". By tracing the measurements back to national standards

and thus to national metrology institutes such as the Physikalisch-Technische Bundesanstalt (PTB), the National Institute of Standards and Technology (NIST) or the National Institute of Metrology (NIM), we achieve the highest quality standards. The internationally recognized calibration certificates and certificates of analysis give you the necessary security for your product quality and strengthen the confidence of your customers.

Unique service – Your product as an individual calibration standard

In addition to in-house manufactured and certified standards, Helmut Fischer's calibration laboratory also offers ISO/IEC 17025 certification for specific customer material. Benefit from customized calibration standards by having your sample certified as a calibration standard by our measurement experts. So now you can use your workpieces for process control, quality control or development – all thanks to the calibration certificate!

Please feel free to contact us! We advise you on suitable calibration standards and what calibration strategy to follow. sales@helmut-fischer.com

How exactly does it work?

MI Magnetic induction method

Probes for magnetic induction measurements consist of an iron core around which an excitation coil is wound. A low-frequency alternating current flows through this coil, creating an alternating magnetic field around the poles of the iron core. If now the probe approaches a magnetizable object – the iron base material of a sample, for example – it amplifies the alternating magnetic field. A measuring coil registers this amplification as a voltage. How high the voltage difference is depends on the distance between the pole(s) and the iron part. For coated parts, this distance corresponds exactly to the coating thickness. The base material must be magnetized, or ferrous, the coating not. This test method is in accordance with DIN EN ISO 2178 and is suitable for coating thickness measurements of galvanic coatings such as zinc and chromium as well as for coatings and plastics.

[MMS® INSPECTION DFT, MP0®/MP0®R, DMP®10-40, DUALSCOPE® FMP100/H FMP150, PHASCOPE® PMP10 DUPLEX, FISCHERSCOPE® MMS® PC2, FISCHERSCOPE® MMS® AUTOMATION]

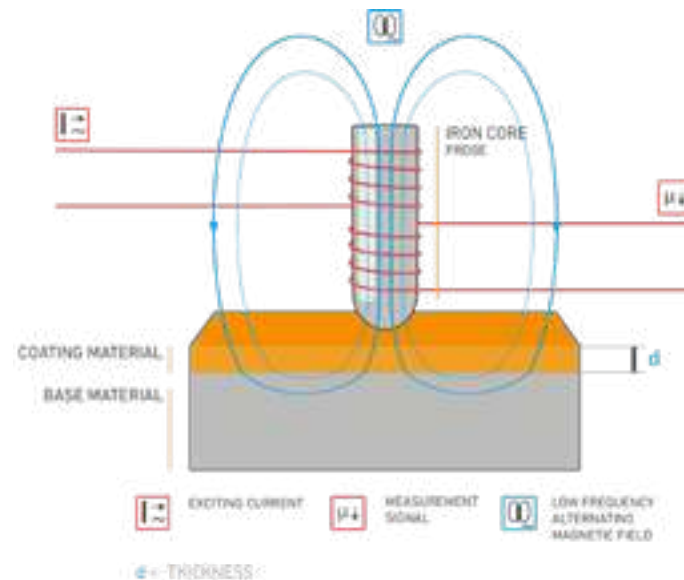

AE Amplitude-sensitive eddy current method

This test method in accordance with DIN EN ISO 2360 uses probes with and without ferrite core. A coil is wound around the core and a high-frequency alternating current flows through it. This produces a high-frequency alternating magnetic field around the coil. If the probe pole comes close to a metal, a so-called eddy current is induced in this metal. This also generates an alternating magnetic field. Since this second magnetic field is opposite to the first, the original magnetic field is weakened. The extent of this weakening depends on the distance between the pole and the metal base material of the object to be measured. For coated parts, this distance corresponds exactly to the value of the coating thickness. Factors that can strongly influence the measurement using the eddy current method include the shape and size of the test part or the roughness of the surface.

[MMS® INSPECTION DFT, MP0®/MP0®R, DMP®10-40, DUALSCOPE® FMP100/H FMP150, PHASCOPE® PMP10 DUPLEX, FISCHERSCOPE® MMS® PC2, FISCHERSCOPE® MMS® AUTOMATION]

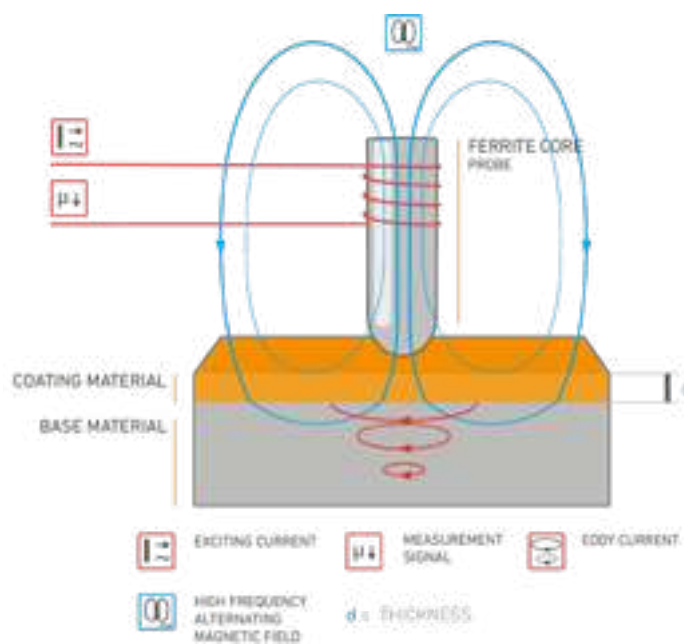

PE Phase-sensitive eddy current method

The method in accordance with ISO 21968 is based on the fact that the coating material and the base material differ sufficiently in electrical conductivity and/or magnetism. The probes have measuring systems consisting of several electrical coils that are placed on a common ferrite core. An excitation current generates a high-frequency magnetic field that induces eddy currents in the material. These, in turn, generate an opposing electromagnetic field that is superimposed on the first field. The resulting field leads to a change in impedance in the measuring coil (= phase shift). The different formation of eddy currents at different coating thicknesses is used for coating thickness measurement. The method is not very sensitive to external influences such as curvature or roughness. Metal layers under an electrically insulating layer, e.g. paint, can also be measured.

[PHASCOPE® PMP10/PMP10 DUPLEX, FISCHERSCOPE® MMS PC2, FISCHERSCOPE® MMS® AUTOMATION]

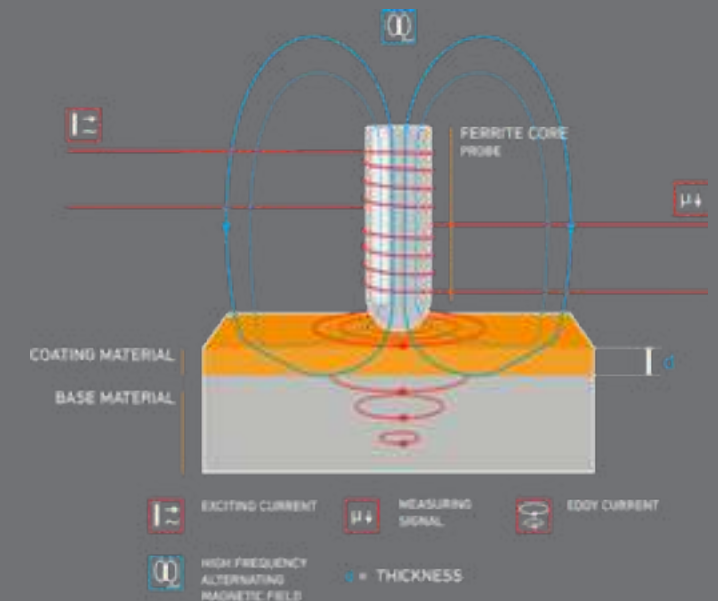

FC Ferrite content

With the magnetic induction method, the ferrite content can be determined quickly and non-destructively in accordance with the Basler standard and DIN EN ISO 17655. For example, weld seams on austenitic steel can be inspected directly onsite and, if necessary, reworked.

[FERITSCOPE® DMP®30]

EC Electrical conductivity

Conductivity measurement not only provides information on how well a metal conducts electricity, i.e. whether it has a high or low conductivity, but also indirectly provides information on its composition, microstructure or mechanical properties. Thus, in many applications, conductivity is an important component of process control or product monitoring. The method used for non-destructive conductivity measurement is the phase-sensitive eddy current method in accordance with DIN EN 50994 standard.

[SIGMASCOPE® GOLD B/GOLD C, SIGMASCOPE® SMP350, FISCHERSCOPE® MMS® AUTOMATION]

DP Dew point

The dew point is the temperature below which the water vapor condenses as dew. If the surface is not completely dry during coating, this can severely impair the adhesion properties of the coating. The dew point is determined on the basis of the object temperature and the relative humidity. In accordance with DIN EN ISO 12944, the object temperature must be at least 3 °C (37,4 °F) higher than the dew point during the entire coating process. With the dew point meter from Fischer, the climate parameters relevant for coating processes, such as relative humidity, air temperature and surface temperature, are easily recorded.

[MMS® INSPECTION DPM]

M Magnetic method

The test method is based on the different magnetic properties between a coating and its base material and is used to measure magnetic coatings on non-magnetic metals or plastics or to test non-magnetic coatings on steel or iron. The measurement is based on the Hall effect, which occurs when a current-carrying conductor is in a constant magnetic field. Magnetic materials, for example a nickel coating, amplify the static magnetic field, which also increases the Hall voltage. This voltage is measured and converted into a coating thickness value in the measuring instrument. The magnetic procedure is carried out in accordance with DIN EN ISO 2178.

[DUALSCOPE® H FMP150, FISCHERSCOPE® MMS® PC2, FISCHERSCOPE® MMS® AUTOMATION]

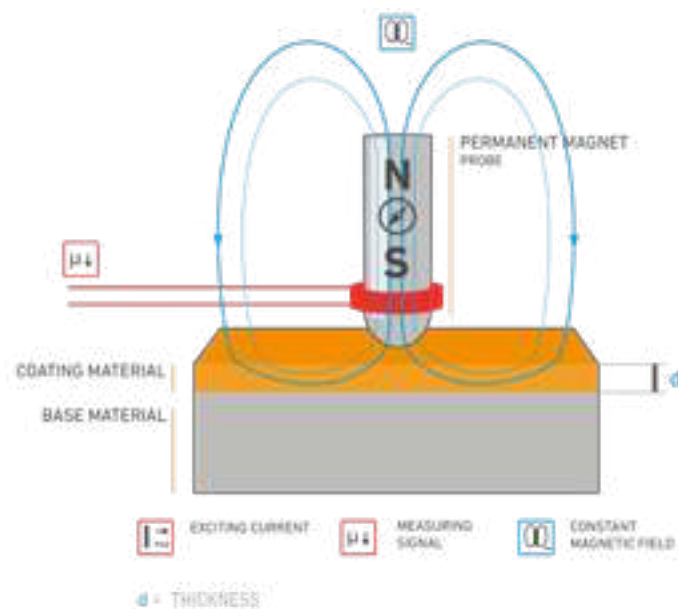

CO Coulometric method

The electrochemical analysis method uses Faraday's law to determine the coating thickness. In accordance with DIN EN ISO 2177, it is suitable for many metallic coatings on any base materials and is a reversal of the electroplating process. In this process, a metal layer is dissolved by a constant electric current. A measuring cell is used for the measurement, which is filled with an electrolyte and placed on the coating. Through the action of electrolyte and direct current, the metal atoms from the coating enter the solution as cations and migrate to the cathode of the measuring cell. Once the coating is depleted and the electrolyte reaches the underlying material, there is an increase in electrical resistance and thus a measurable voltage jump, which leads to an automatic shutdown of the measuring device. The coating thickness can be calculated from the time taken for the dissolution process.

[COULOSCOPE® CMS2/CMS2 STEP]

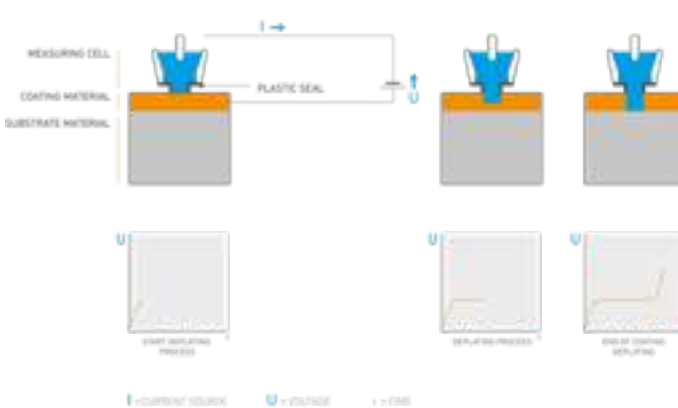

SP Surface profile

The surface profile influences the performance of a coating. It affects the adhesion, hiding power and material consumption. Very smooth surfaces with low profiles are difficult to paint because the coating adheres poorly. Surfaces with high profiles, on the other hand, require very thick coatings. Fischer's tactile devices and probes record a one-dimensional contact section profile. They measure peak-to-valley height differences in accordance with ASTM 4417, Method B.

[MMS® INSPECTION SPG]

BB Beta-backscatter method

In this method, an isotope source emits beta rays (electrons). These penetrate the coating and the base material of the workpiece and are scattered by the atoms of both materials. The number of backscattered electrons is counted to measure the thickness of the coating. This makes it possible to measure the thickness of layers of any material on any base material, provided that the atomic numbers of the layer and base material differ sufficiently. Possible applications include the measurement of very thick gold layers on nickel, bronze or ceramics, silver in copper tubes for high-current contacts in the printed circuit board industry and the electrical/electronics industry, or the thickness measurement of thin paint, oil and lubricant films on steel parts in steel processing. In general, the beta-backscatter method is a quite universally applicable coating thickness test method. The beta-backscatter method is performed in accordance with DIN EN ISO 3543, ASTM B567 and BS 5411.

[BETASCOPE®]

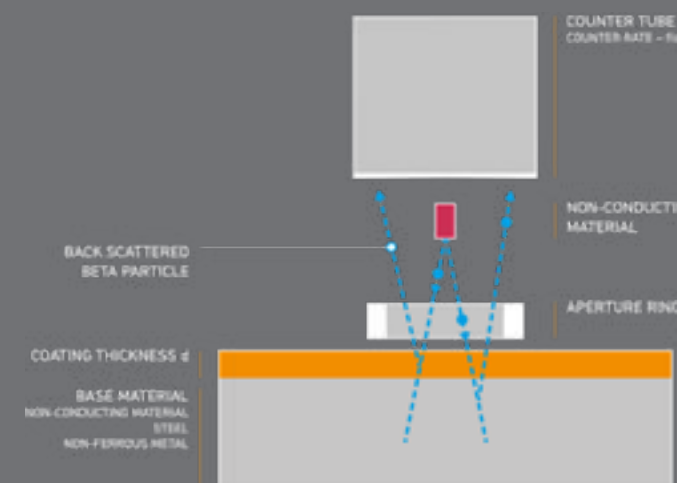

D Duplex method

Duplex coatings are often used in corrosion protection and automotive construction because they are characterized by a very long service life. Duplex coatings consist of a zinc coating in combination with one or more colored coatings. The overall system of zinc and paint can protect the steel from corrosion for many years. For the measurement of duplex systems, magnetic induction and phase-sensitive eddy current test methods are used together in one probe. For zinc coatings from about 150 µm, however, the penetration depth of the phase-sensitive eddy current method is no longer sufficient to reliably determine the coating thickness. For this reason, the combination of the magnetic induction and the amplitude-sensitive eddy current method is used in such cases. According to the DIN EN ISO 12944 standard, the measurements are performed in accordance with DIN EN ISO 2178, DIN EN ISO 2360 and DIN EN ISO 21968.

[DMP®10-40, DUALSCOPE® FMP100/H FMP150, PHASCOPE® PMP10 DUPLEX, FISCHERSCOPE® MMS® PC2, FISCHERSCOPE® MMS® AUTOMATION]

MR Microresistivity method

This method is suitable for measuring the thickness of electrically conductive layers on insulating substrates in accordance with ISO 14571. Copper coatings on printed circuit boards and multi-layer PCBs are frequently checked using this method. The advantage of this method is that other layers or intermediate layers in the PCB have no influence on the measurement, so that the thickness can be determined precisely even with thin layers. This method uses probes with four needles arranged in a row on the underside of the probe. When the probe is placed, current flows between the two outer needles. The coating acts as an electrical resistance to which a voltage drop is measured with the two inner needles. The resistance and thus the voltage drop increase as the coating thickness decreases, and vice versa. Probe-specific specifications (minimum specimen size, minimum distance to the specimen edge) prevent systematic error with particularly specimens.

[SR-SCOPE® DMP®30, FISCHERSCOPE® MMS® PC2, FISCHERSCOPE® MMS® AUTOMATION]



Application consulting

Everything for your measuring task

Your quality is our mission

Successful quality management is the foundation of a successful company. We make a measurable contribution to this, as only the right measurement technology combined with the right measuring method and correct use of devices lead to reliable, valid quality control measurements. Our specialists are just the right point of contact for your concerns and challenges, your requirements in measurement technology, and for all other questions relating to your measuring task.

Wide-ranging expertise for precise measurement results

Specialists from the fields of physics, materials science and engineering in seven application laboratories in Germany, Switzerland, China, USA, India, Japan and Thailand are available to provide you with advice and assistance, whether helping to choose the right measuring instrument, developing an in-depth measuring strategy or defining the right measurement program. Especially when solving complex measuring tasks, you benefit from our application consulting. This way, your employees always know what is important for the measurement.

Get an overview of our product portfolio in the application laboratories on site. Our devices are available for you to test.

All application laboratories are optimally networked with each other as well as with research and educational institutions and industry. In this way, we ensure that you have access to cutting-edge expertise worldwide. And we make sure that we have the right answers to your questions.

Our services at a glance

- Technical advice by email, telephone or in person at the application laboratory
- Support with operation and calibration as well as with the implementation of new measurement tasks
- Individual sample testing with your components
- Sample testing live: We measure your sample and you are live with us
- Contract measurements with inspection report according to ISO 17025 (only in selected laboratories)

Global support for your application



Whether remotely or on site, we stand by your side with expert advice and answers for your application questions. Visit Fischer in one of our application laboratories or get advice from your local Fischer representative.

CHINA

Shanghai

china@helmutfischer.com

China, Hong Kong, Taiwan

GERMANY

Sindelfingen and Berlin

applikation@helmut-fischer.com

Northern and Eastern Europe, Baltic States, Central Africa

INDIA

Pune

india@helmutfischer.com

South Asia, Middle East

JAPAN

Tokyo

japan@helmutfischer.com

Japan, Korea

SWITZERLAND

Hünenberg

applications@helmut-fischer.com

Africa, Australia, Brazil, Europe, Southwest Europe

THAILAND

Bangkok

thailand@helmutfischer.com

Southeast Asia

USA

Windsor, CT

info@fischer-technology.com

North and South America

APPLICATION CONSULTING ON SITE

In every Fischer branch

You can find your contact person under:

www.helmut-fischer.com



Service

A reliable partner for the entire life of your device

All-round worry-free package with maximum flexibility

For over 70 years, we have been supporting our customers with outstanding products and unique services. We attach just as much importance to fast and reliable service as we do to the quality of our products. As part of our 360° support, our service experts will assist you with the commissioning, inspection, and maintenance of your device. With our product trainings, we teach you how to use your measurement system.

Your advantages of regular inspections

To ensure that your devices stay with you over a long period of time and provide reliable measured values, we recommend regular inspections – ideally at annual intervals. All inspections are carried out by our trained and experienced service personnel. Thanks to our global support network, we are flexibly available in your area and provide individual advice and support on site with fast response times.

Through regular inspections, you extend not only the life of your device but also keep your downtimes to a minimum. We plan inspection times together with you at an early stage and coordinate them with your production schedule. The same applies to our spare parts: We only use original parts of the highest quality.

There for you in every respect

- Telephone hotline and remote support
- On-site service in 21 countries and in your national language
- Individual product trainings
- Customized inspection contracts
- Recertification and calibration service for reliable measurement results
- Individual task programming
- Provision of rental equipment on request*

* Only for selected devices and in selected subsidiaries.



“ At Fischer, the customer relationship does not end with the sale of the device – it begins then. ”

Paul Comer, Technical Director at Graphic Plc, GB



Do you need technically sound advice?
Then contact us!
sales@helmut-fischer.com

“ We can only recommend Fischer instruments for quality assurance of surfaces. We have been more than satisfied with the measuring devices and the competent advice over many years. ”

Tomasz Suchcicki, Quality Manager, Aalberts Surface Technologies GmbH, DE



You can find us in:

AMERICA | EUROPE | AFRICA | MIDDLE EAST | ASIA & PACIFIC



- Subsidiaries
- Authorized distributors

Made in Germany! Our measuring devices and software as well as all accessories are developed, produced, and continuously optimized in-house – always with the goal to make our customer's world measurably easier.



Our experienced staff will be happy to advise you on site and in your national language. Please find your personal contact at www.helmut-fischer.com



Discover Helmut Fischer Global on social media!

Global Sales, Application and Service